

# Packaging requirements of Active Optical Cable Assemblies

## Paradigm Notes TE CIS OPG

Data Communication, Optical Products Group

Michiel Boermans

Business Development

July 11, 2011



# All Protocols Will Go Optical

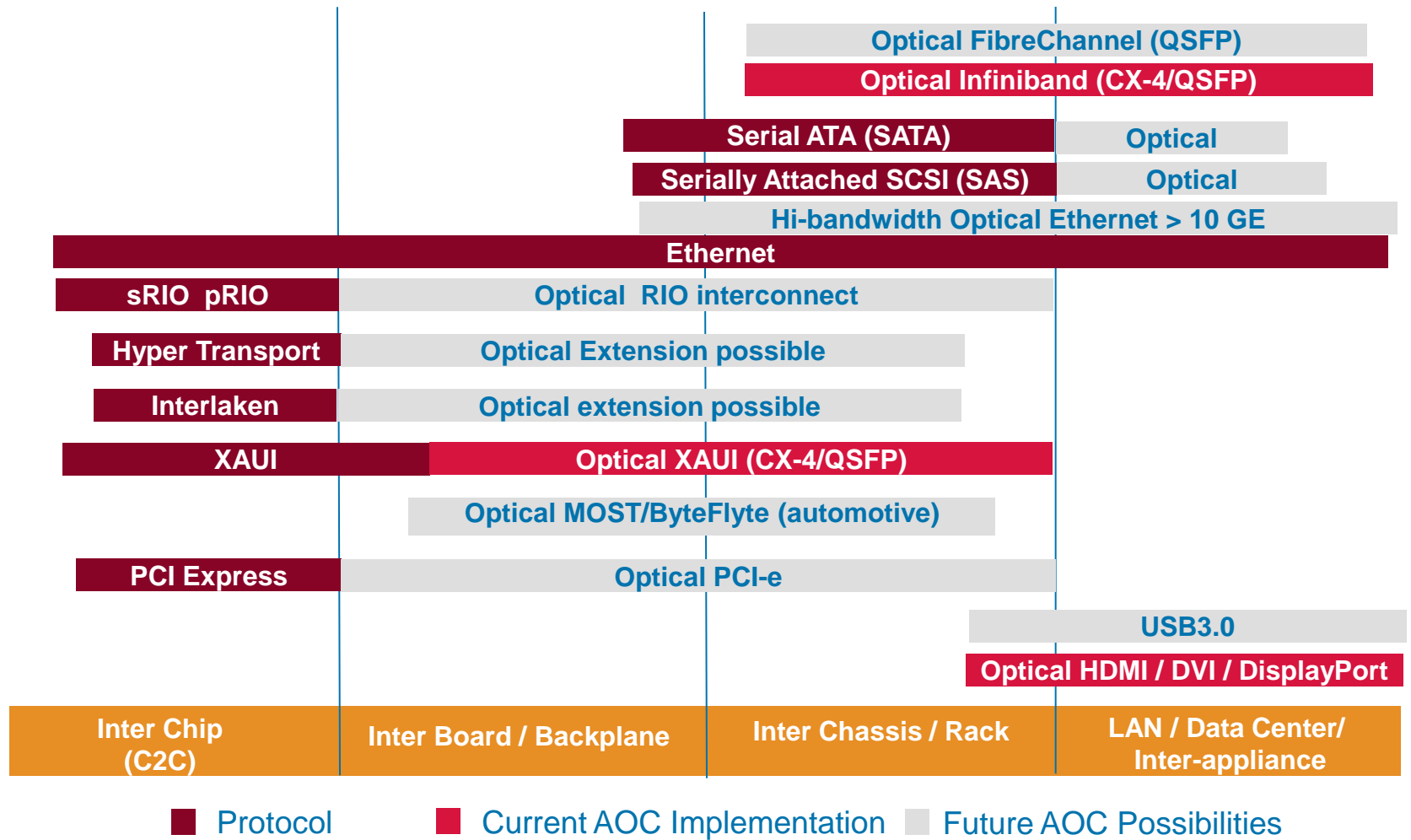

# IBTA Infiniband Roadmap: HPC's mainly

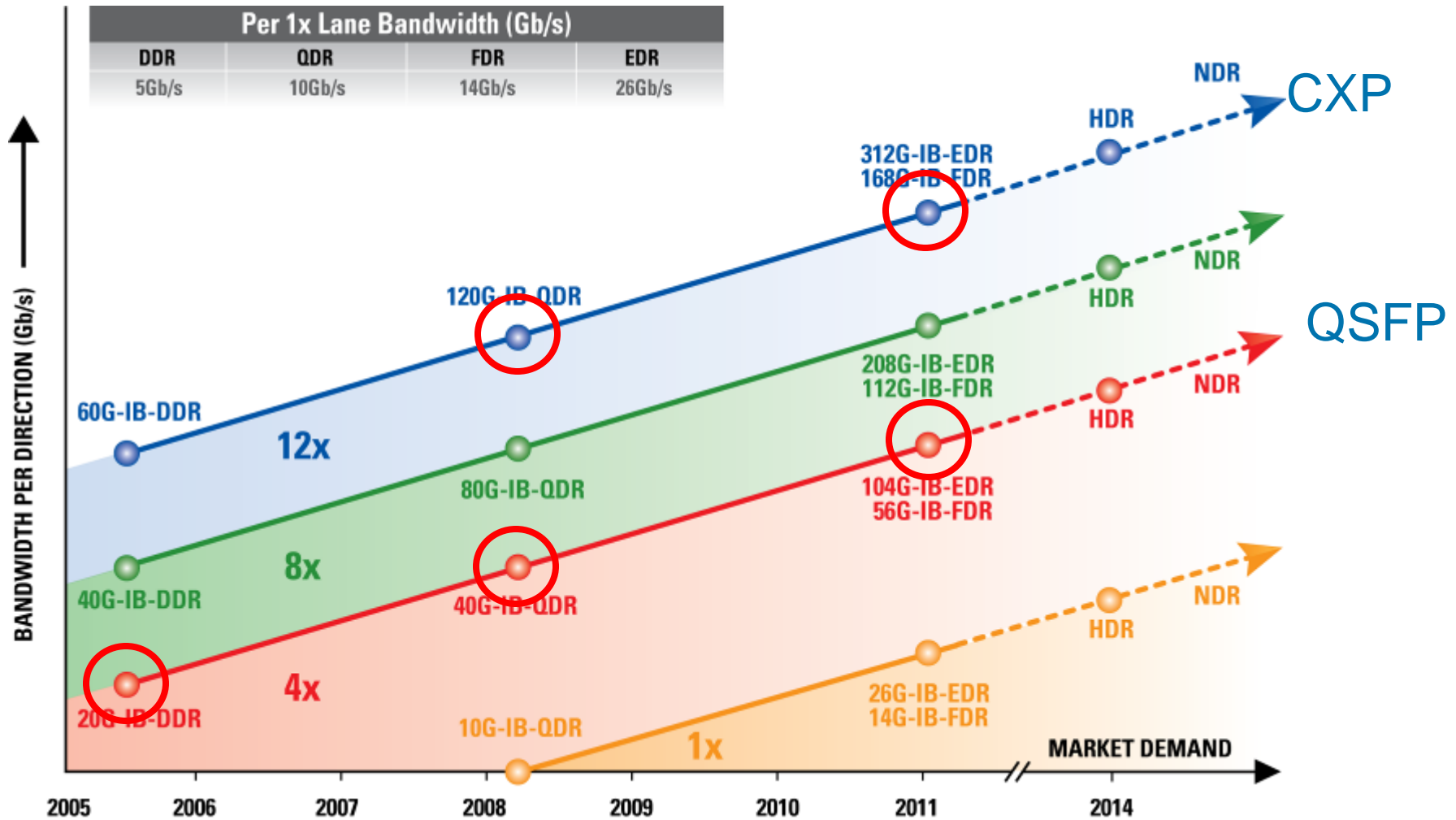

Issued a while ago: so far pretty correct!

# AOC's, Present day Assembly

System contains Tyco Electronics property

Rx array

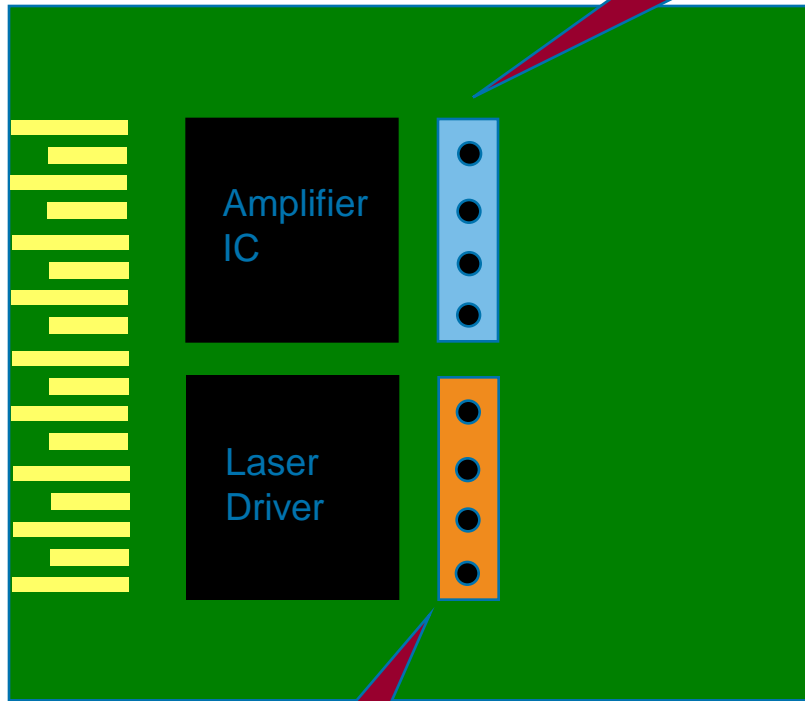

Tx array

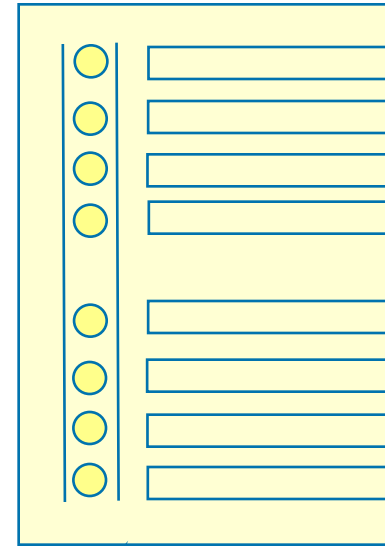

Lens



Fibers

# How do they work? 2, Two ends cross connected

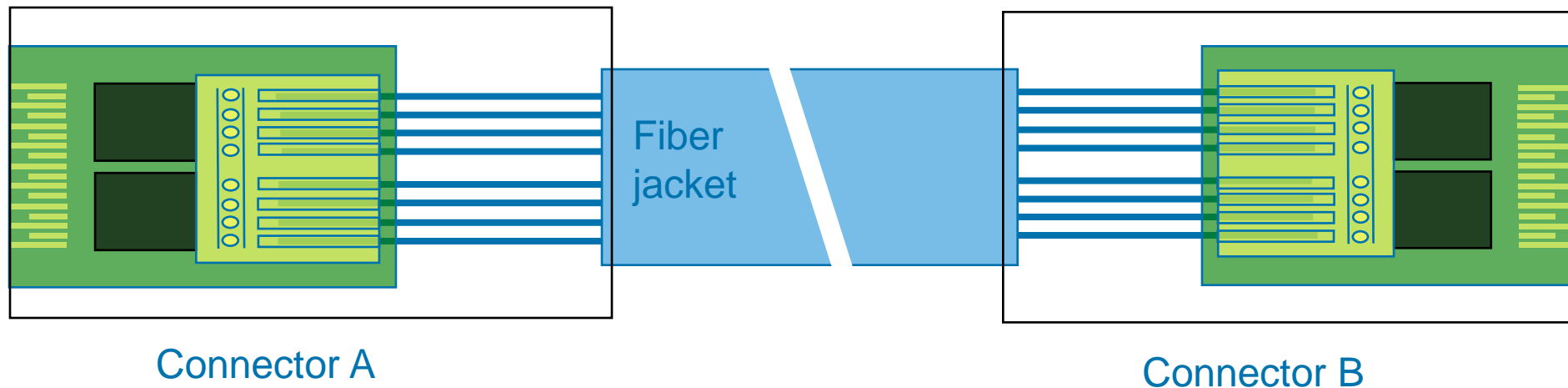

# PARALIGHT - Key Technologies

Molded Optics Interconnect For Multi Fiber Package

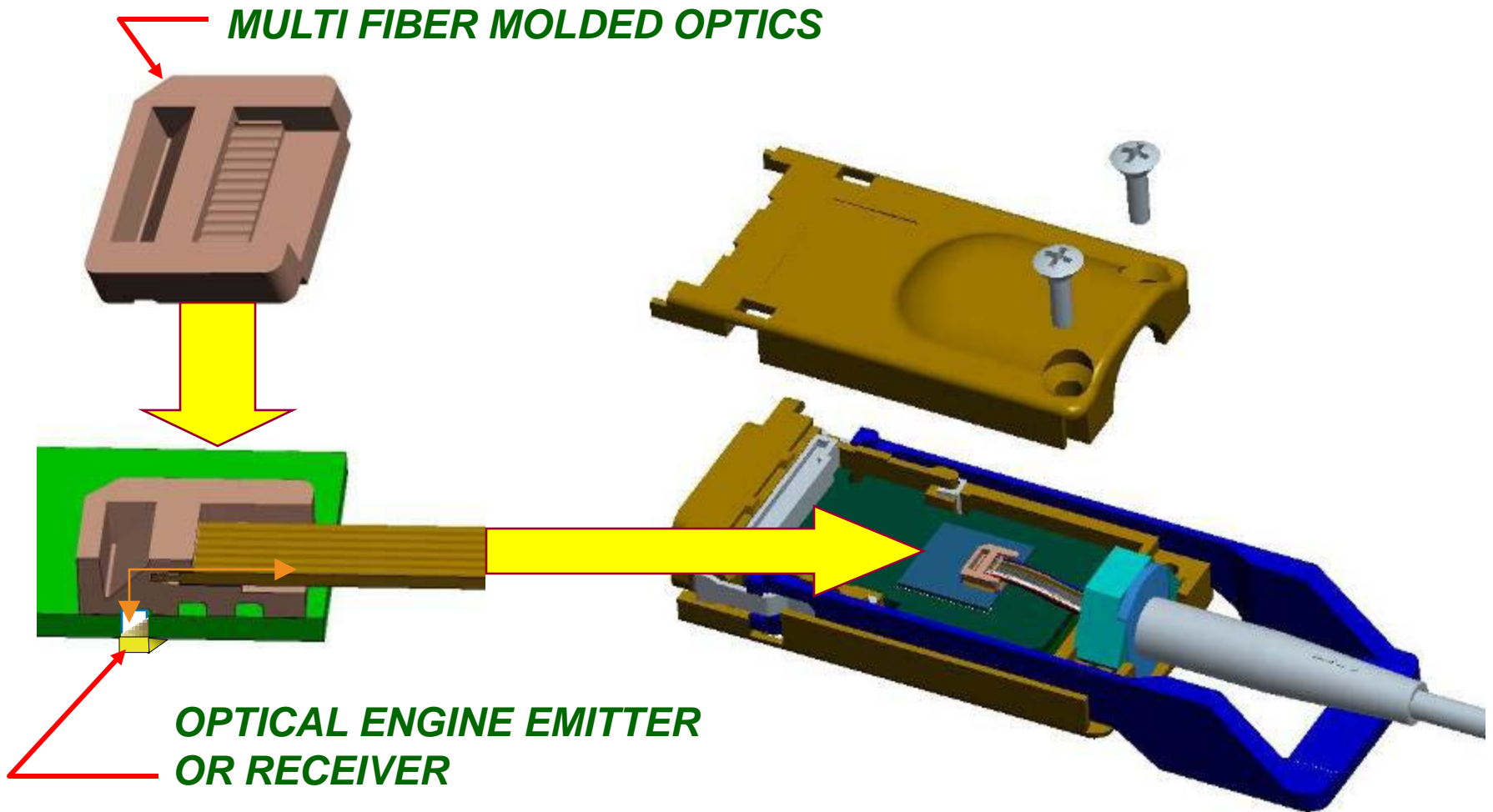

# JePPIX EuroPIC InP integrated 'engine'

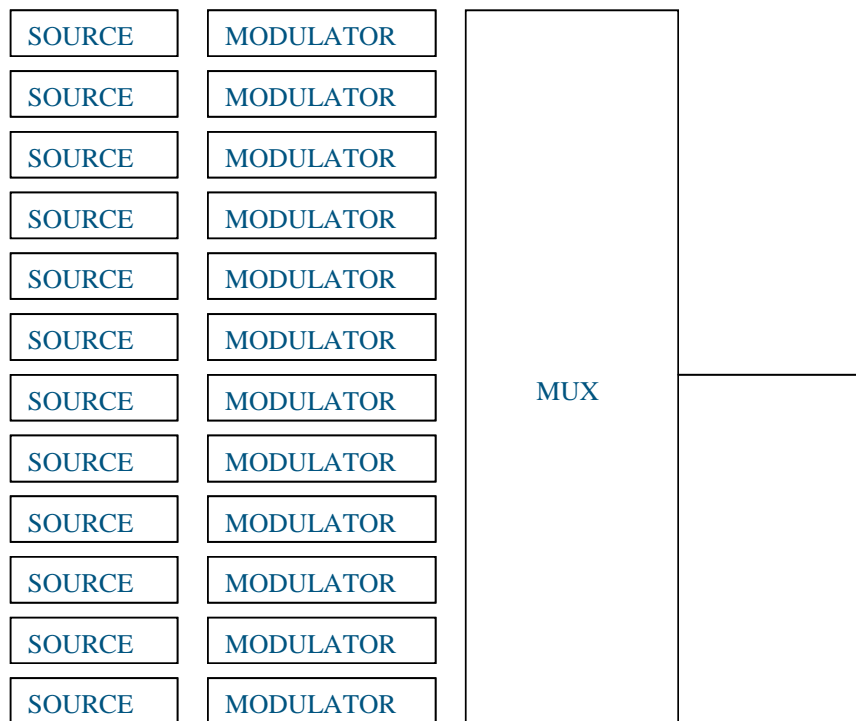

Coupling to one fiber:

- Single mode
- Smaller tolerances

If automated:

- Lower cost

Delight:

- cost
- Integration: what else?
- Channel count
- User case: distance



Michiel Boermans

email: [michiel.boermans@te.com](mailto:michiel.boermans@te.com)